

Concept Generation

Dr. Julie Linsey

Woodruff School of Mechanical
Engineering

What you're going to learn today:

How to:

- generate 40% more ideas in a team
- identify 3x as many analogies

Agenda for Class

1. Idea Generation
2. “Rules” for Idea Generation
3. Brainstorming with Mind Maps
4. 6-3-5 (a brainwriting technique)
5. Morph Matrices
6. Checklist approaches

The Problem is Defined– Now What?

- Are you creative?
- Is it important for engineers to be innovative?
- How are concepts developed?

Brilliant Ideas take Time and Effort

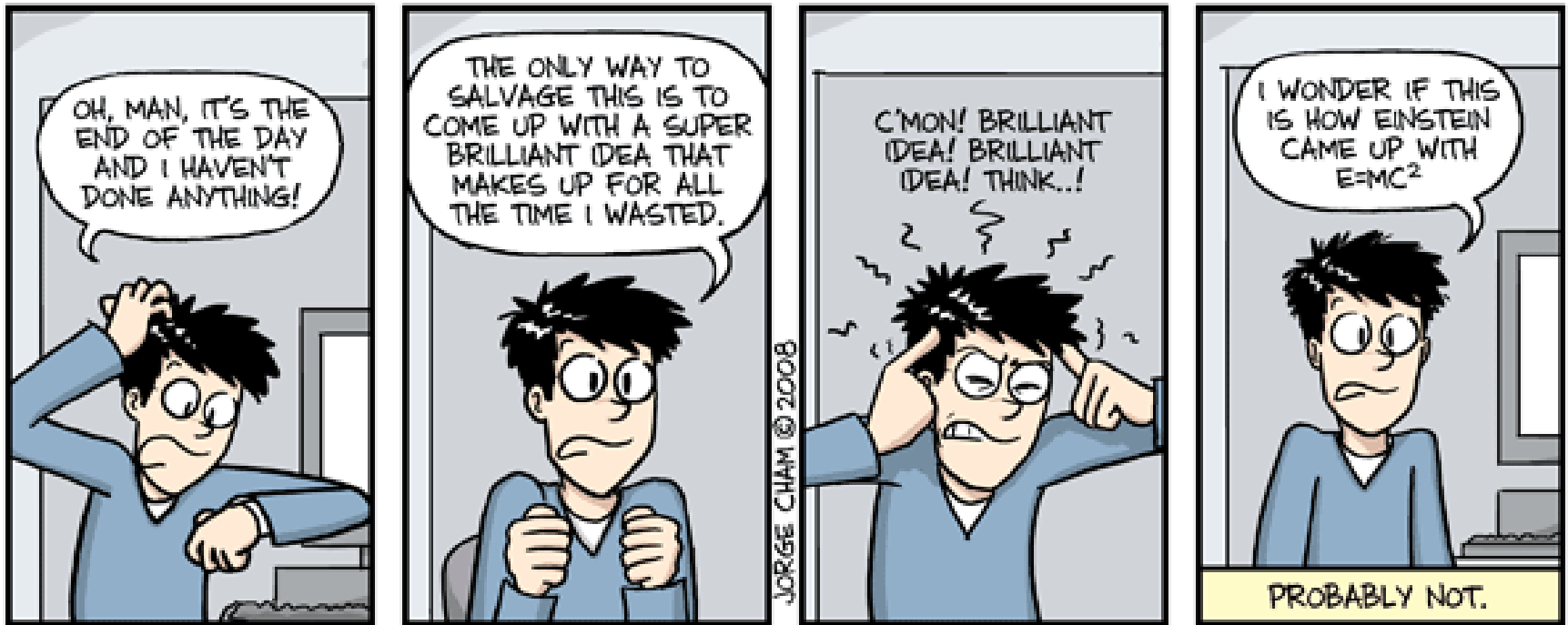

How to be a good idea generator (a.k.a. creative)

- Practice, practice, practice
- “Genius is 1% inspiration and 99% perspiration!”
 - Thomas Edison
- “The secret of creativity is knowing how to hide your sources”
 - Einstein
- “I use not only all the brains I have but all that I can borrow.”
 - Woodrow Wilson
- References your sources for this class and explain their connection to your results
- “Opportunity is missed by most people because it is dressed in overalls and looks like work.”
 - Thomas Edison

Starting Points for Concept Generation:

Parts of the design problem to solve

1. Individual functions
(from a function structure)
2. Function groups (higher levels of a function tree, modules)
3. Product layout (*concept variants*)

Why Use Concept Generation Methods?

- Initial solutions are rarely the best
- Helps prevent design fixation
- Increase skills in concept generation
- Amplifies concept generation ability

Basic “Rules” of Idea Generation:

Applies to all Idea Generation Methods

- Suspended judgment of ideas
- Present all ideas, including the bad or silly ones
- Wild and Crazy Ideas are good
- Build from others’ ideas
- Strive for quality and quantity
- Review the problem at the beginning of the session

Overview of Methods

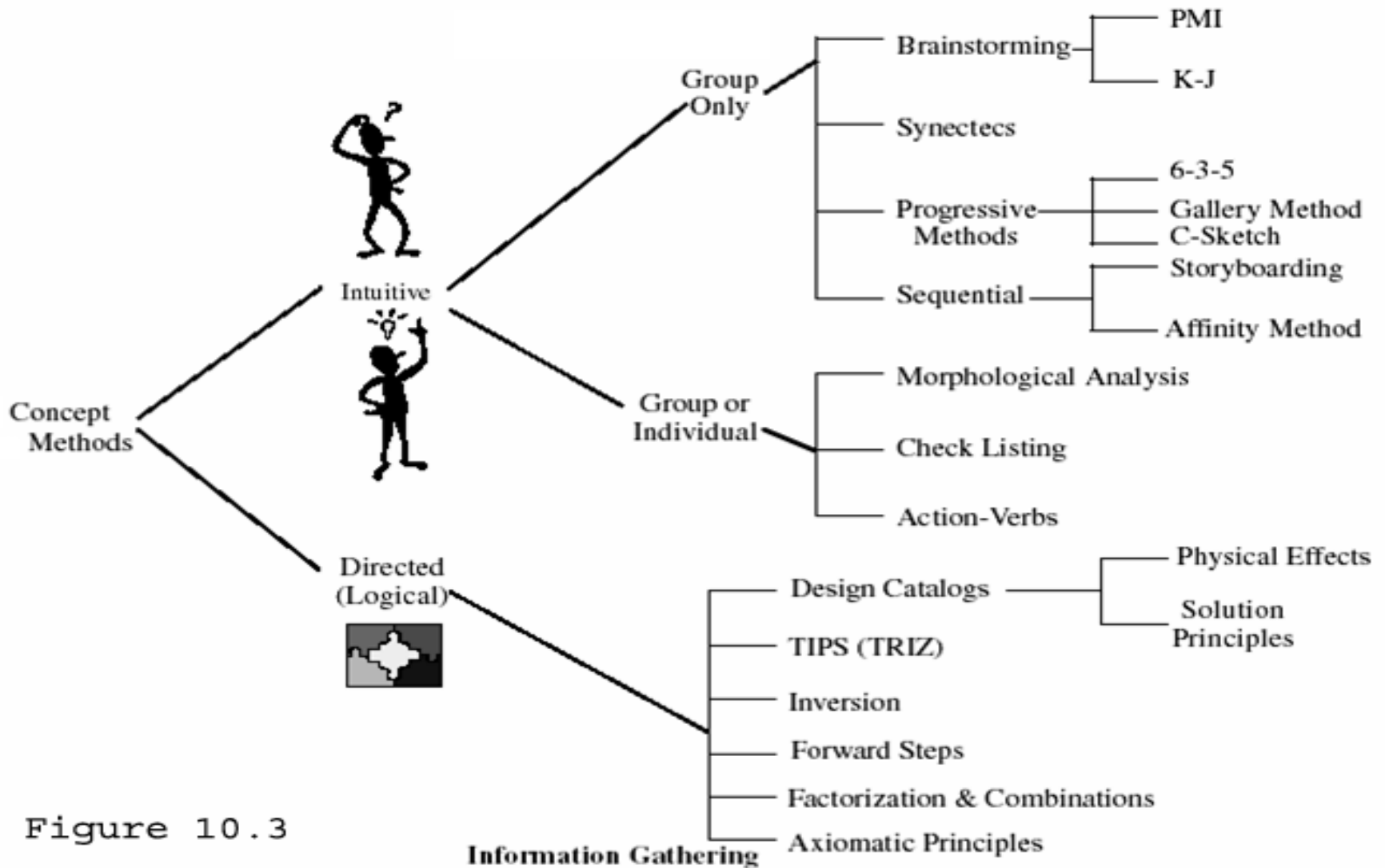

Figure 10.3

Brainstorming Procedure

1. Select a facilitator
2. Review the problem ~10 minutes -
(task clarification, CN's, specifications,
etc.)
3. Rapid idea generation
4. When ideas trickle, either stop or use idea
generators (analogies, physical principles,
etc.)

Recording a Brainstorm: Mind Maps

- Step 1: Write Problem in the center
- Step 2: Add ideas: cluster into hierarchical groupings
- Look for categories!!
- Groupings help lead to more ideas
- Documents brainstorming
- Power of technique – utilizes fact that ideas in memory are linked by association

Mind Maps

- Step 1: Write Problem in the center
- Step 2: Add ideas: cluster into hierarchical groupings
- Look for categories!!

Detect & display the location of a golf ball

Bright colored ball	Smoke trail
Electronic Grid with ball emitter	Shorter golf course
Sound horn in ball	Putt-Putt golf
Exploding ball	Spotters paced every 10 m
Golf lessons	Colored golf course
GPS System	Trajectory calculation system
Scent-Human	Robotic arm hits ball
Scent-Dog	Mini-camera in ball
Virtual golf	Light emitting ball
Pressure sensitive ground	Ball shoots flare
String attached to ball	Plexiglass side walls on golf course
	Funnel shaped golf course
	Speaker in ball; use microphone to call yourself
•	•
•	•
•	•

▼ **Figure 10.5.**

Partial brainstorming list generated for the function of “detecting a golf ball.”

Fig. 10.6:
Mind Map

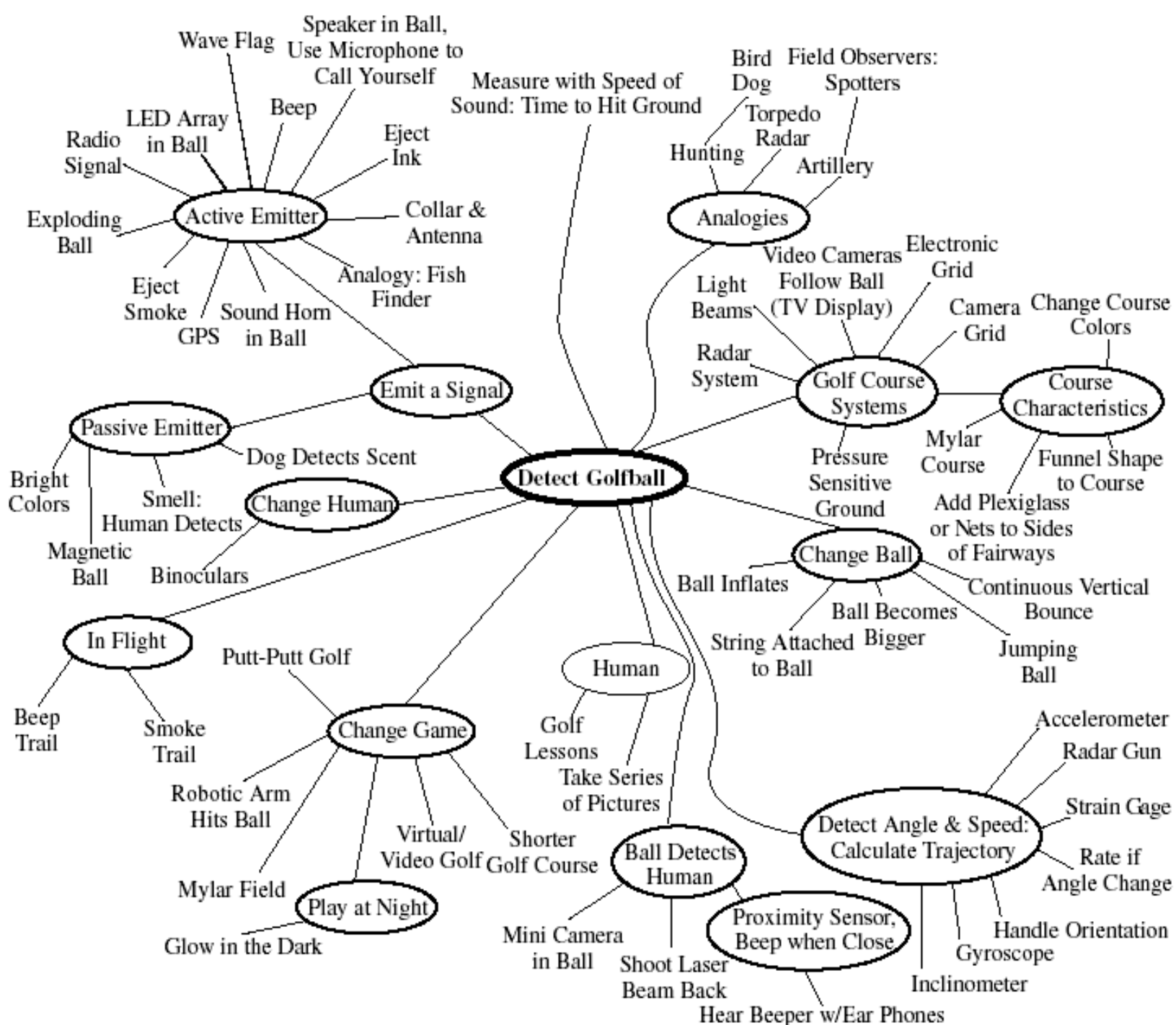

Software

- Mindmanager
- others

Include Pictures in Mind Maps

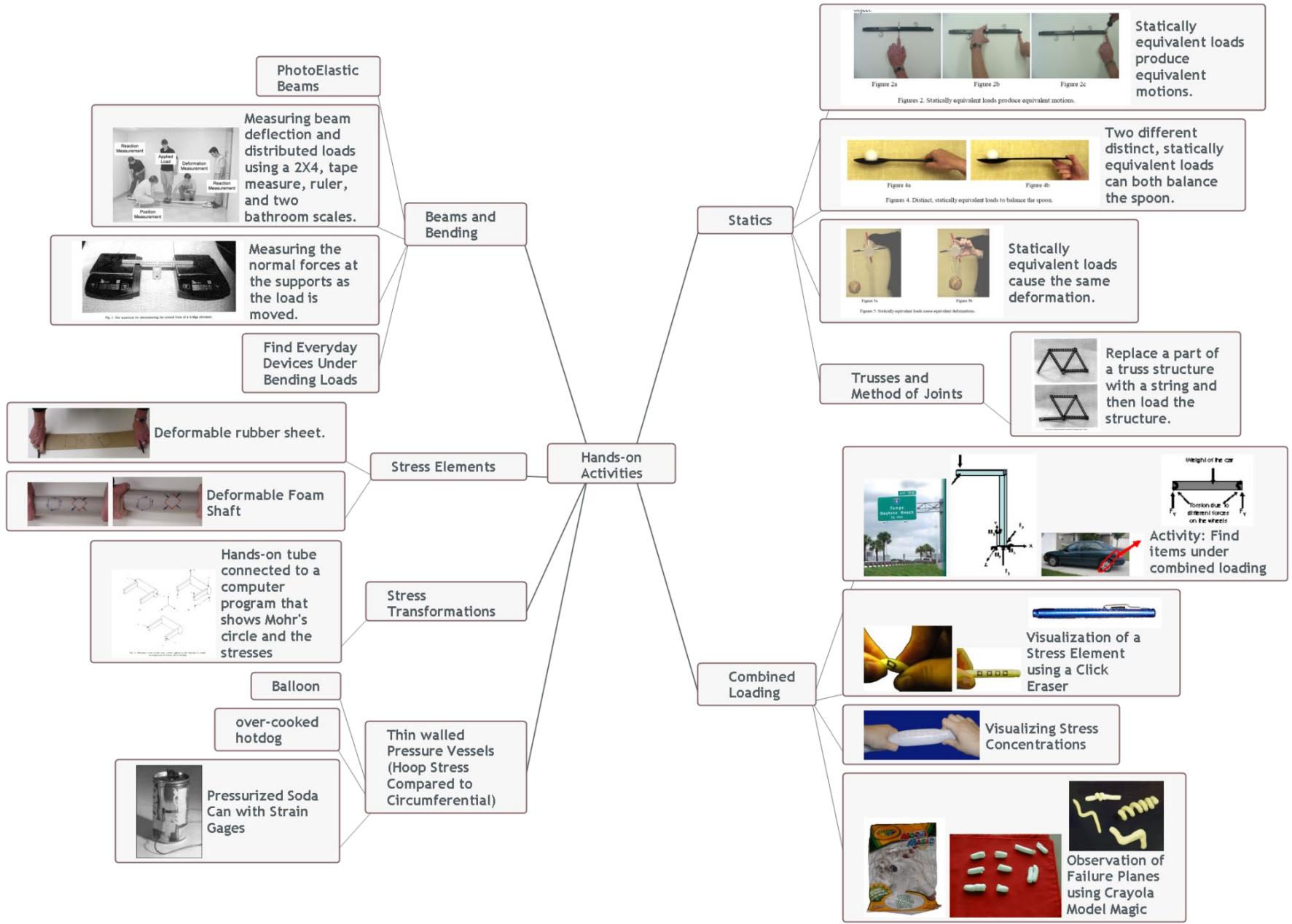

A Sticky Note Mind Map



Generate 40% More Ideas!!!!

6-3-5 (brainwriting)

- Procedure
 - 6 – group members
 - 3 – ideas (sketches & keywords) per paper
 - 5 – exchanging papers

Guidelines

- Each rotation allows adding to and synthesizing (combining) ideas
- Avoid negative comments
- No talking! (Emphasizes sketching)
- Sketches with brief keywords

6-3-5 Illustration



10 Minutes

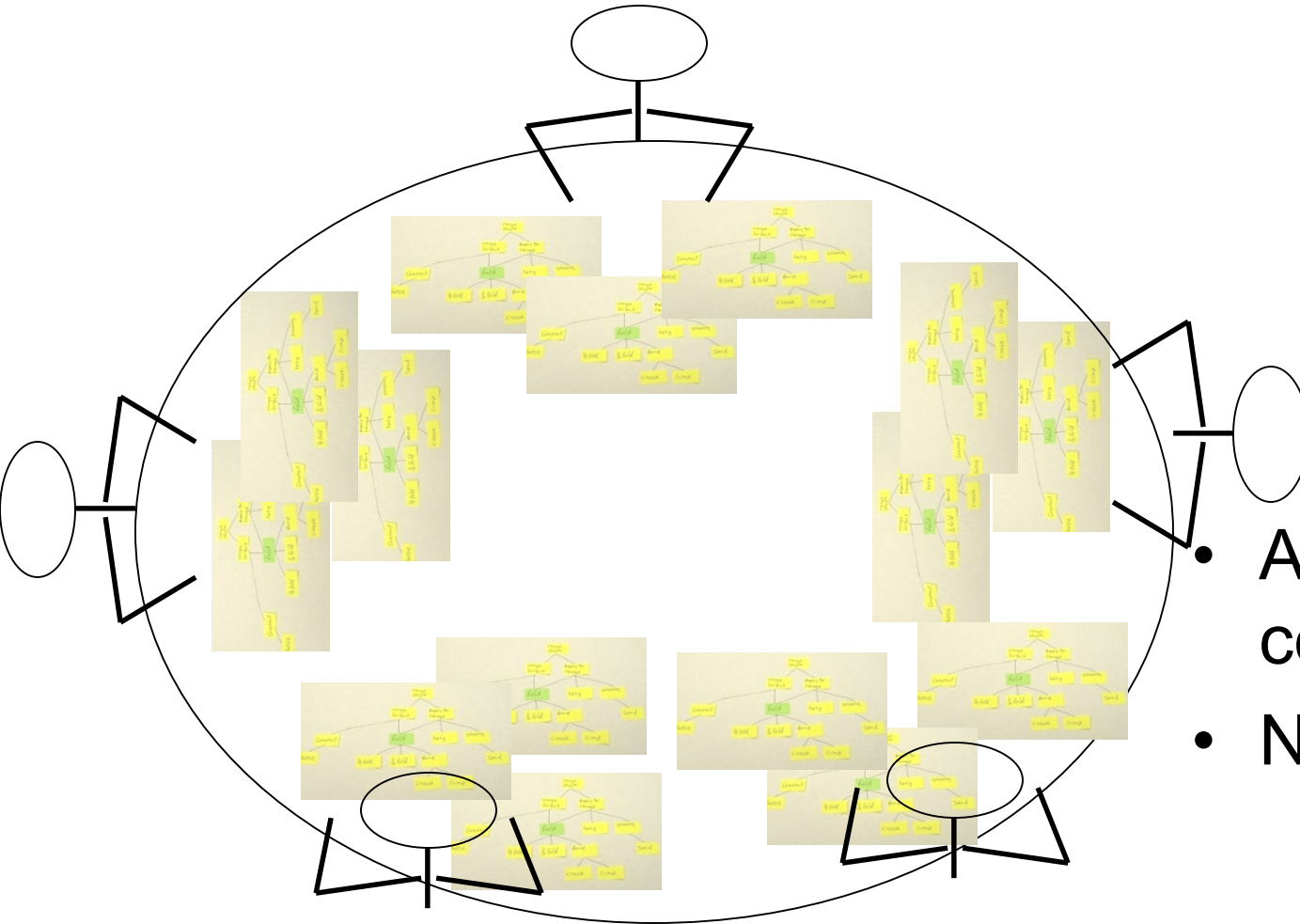

- Avoid negative comments
- No talking!

6-3-5 :

Rotate sets of concepts, spend 7 minutes adding ideas and combining

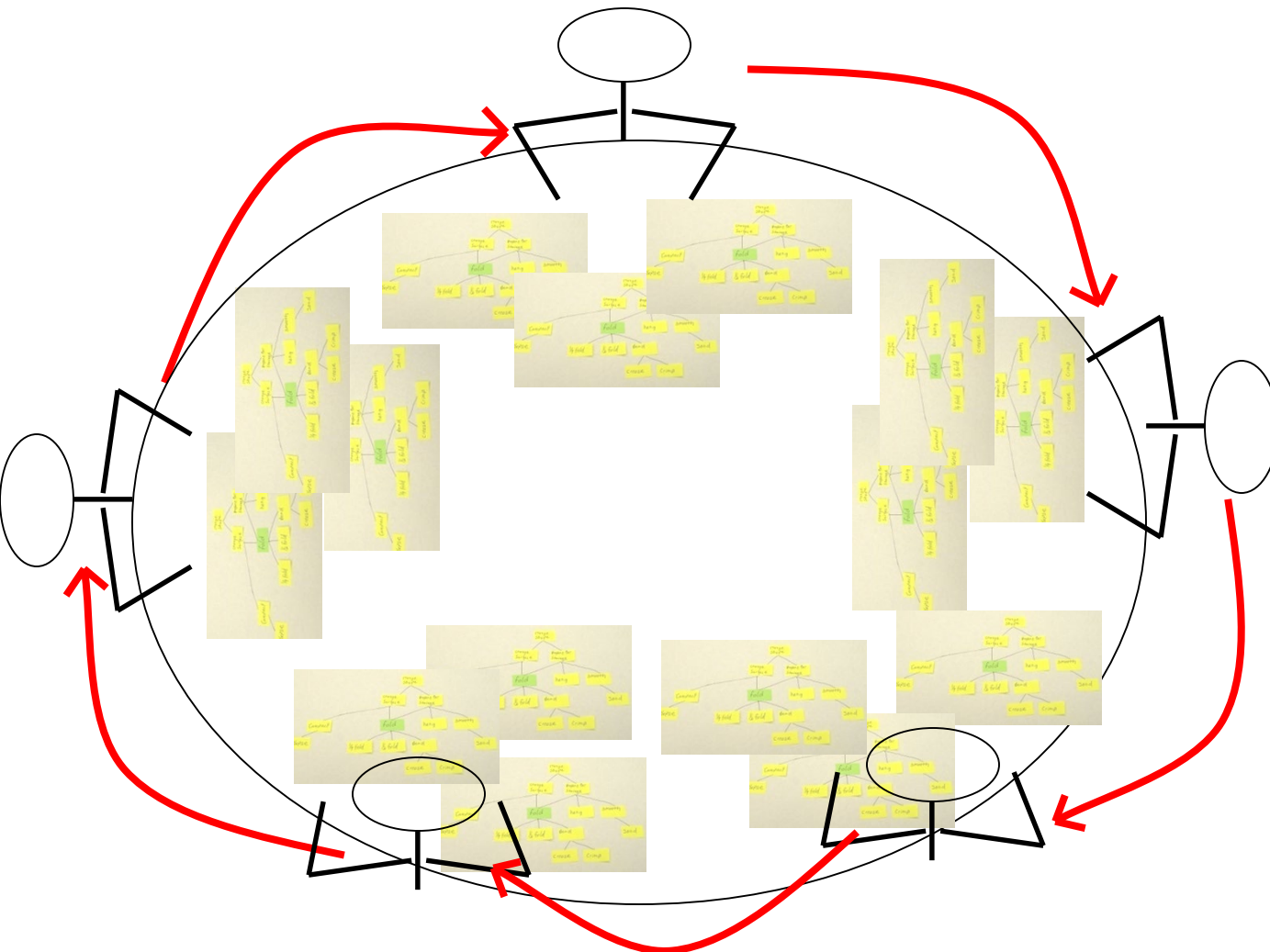

**7 Minutes More
per exchange**

6-3-5 Case Study: Power Driver

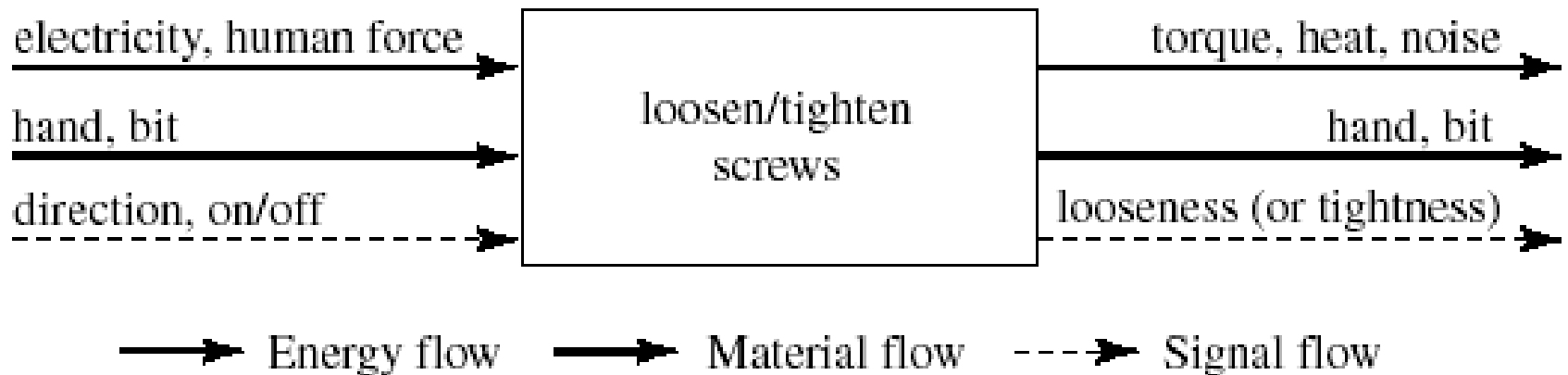

F10.7:
6-3-5

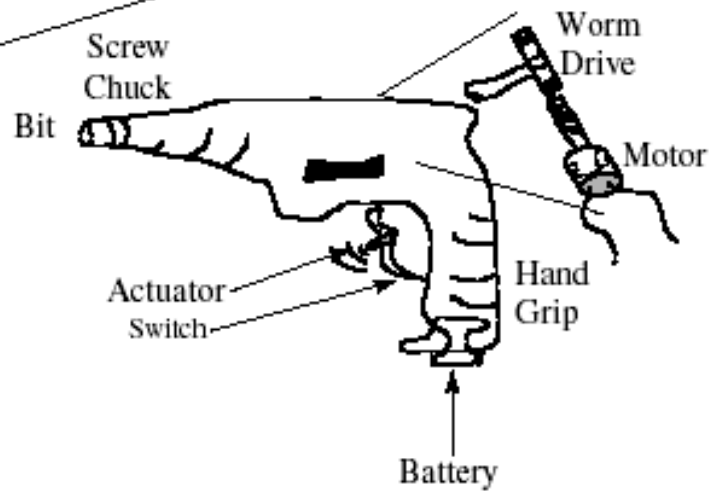
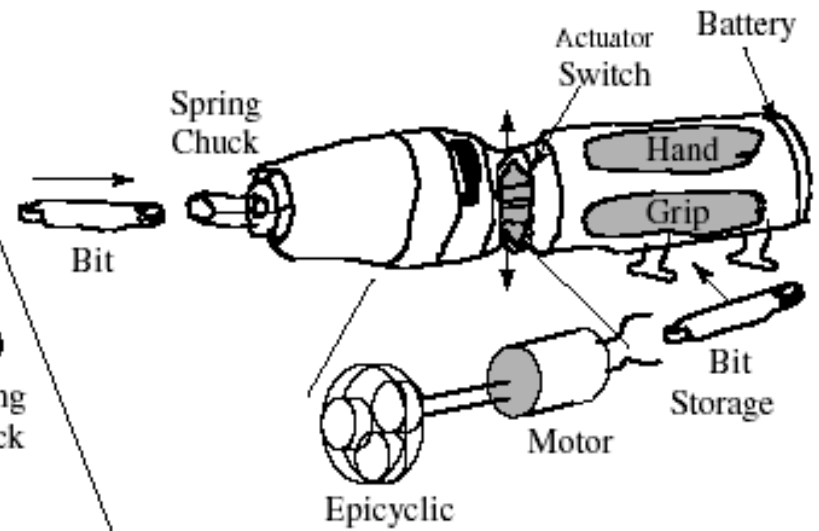
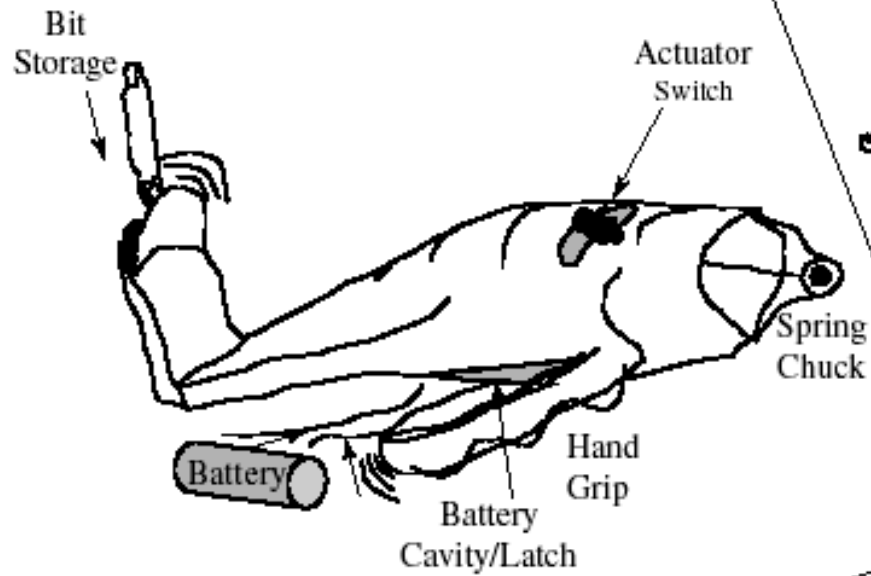
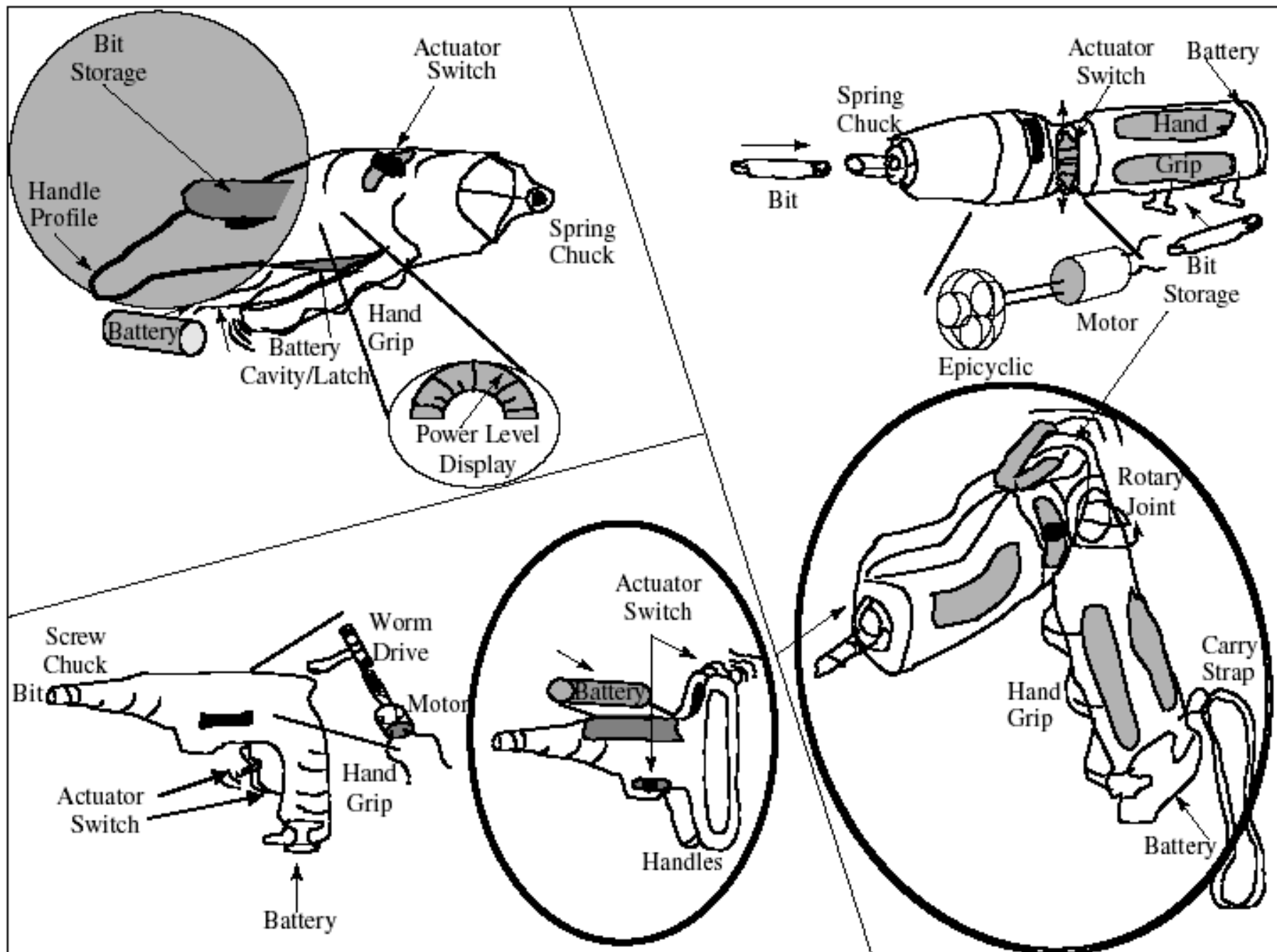
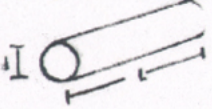
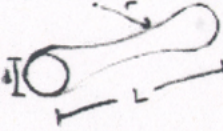





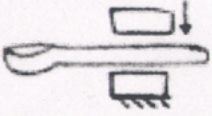
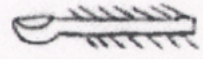

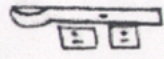
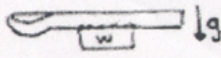
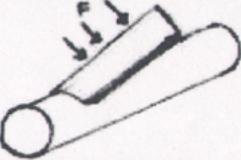
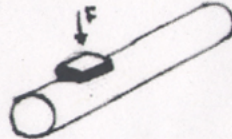
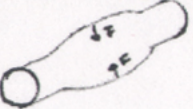
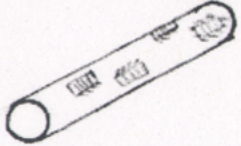

Figure 10.8: 6-3-5, Second Rotation



Morph Matrix Example

	Cylindrical	Toroidal	Prism	Outer Handle	Deformable
Accept User (shape)					
(surface)	Dycem	Ridges	Santoprene		
					
Accept Utensil	Clamping	Permanent Attach	Slot	Magnets	
				 (metal spoon)	
Accept Energy	Eccentric Weight	Lever	Button	Squeeze Tube	Photocells
	 (Hoover energy)				

Morph Matrix Example: Ways to Store Energy

Type of Energy	Mechanical	Hydraulic	Electrical	Thermal
Principle				
1				
2				
3				
4				

Checklists & Idea Generators for Concept Generation

- Use when the group “runs” out of ideas
- Jump starts new ideas
- Have the list ready during a Concept Generation Session

TABLE 10.3. IDEA GENERATORS FOR INTUITIVE CONCEPT GENERATION METHODS

Idea generator	Questions or application
Make analogies	What analogies exist in nature? What analogous products exist in any product domain? How do these products solve the same product functions?
Wish and wonder	What if . . . ?
Sketch/use physical models (e.g., Tinkertoys or LEGOs)	What would an idea look like? How does this model satisfy the function? What can we change?
Eliminate or minimize?	If we remove a feature, how does the device perform? What can we use to replace the feature? What if a feature were smaller? What should I omit? Should I divide it? Split it up? Separate it into different parts? Understate? Streamline? Make miniature? Condense? Compact? Subtract? Delete? Can the rules be eliminated?
Substitute	What can be substituted? Who else? What else? Can the rules be changed? Other ingredient? Other material? Other process or procedure? Other power? Other place? Other approach? What else instead?
Combine	Can we combine purposes? How about an assortment? How about a blend? An alloy? Combine units? What other article or device could be merged with this?
Adapt	What else is like this? What other idea does this suggest? Does the past offer a parallel? What could I copy? Whom could I emulate? What idea could I incorporate? What other process could be adapted?
Modify or magnify	What can be magnified, made larger, or extended? What can be exaggerated? Overstated? What can be added? More time? Stronger? Higher? How about greater frequency? Extra features? What can add extra value? What can be duplicated? How could I carry it to a dramatic extreme? Convert a round action to straight? How can this be altered for the better? What can be modified? Is there a new twist? Change meaning, color, motion, sound, odor, form, or shape? Change name? What changes can be made in the plans? In the process? In the marketing?
Put to other uses (repackage an old idea)	What else can this be used for? Are there new ways to use as is? Other uses if modified? What else could be made from this? Other extensions? Other markets?
Reverse or rearrange	What other arrangements might be better? Interchange components? Other pattern? Other

SCAMPER

- Substitute
- Combine
- Adapt
- Magnify or minify
- Put to other uses
- Eliminate or elaborate
- Rearrange or reverse

SCAMPER: Substitute, Combine, Adapt, Magnify or minify, Put to other uses, Eliminate or elaborate, Rearrange or reverse

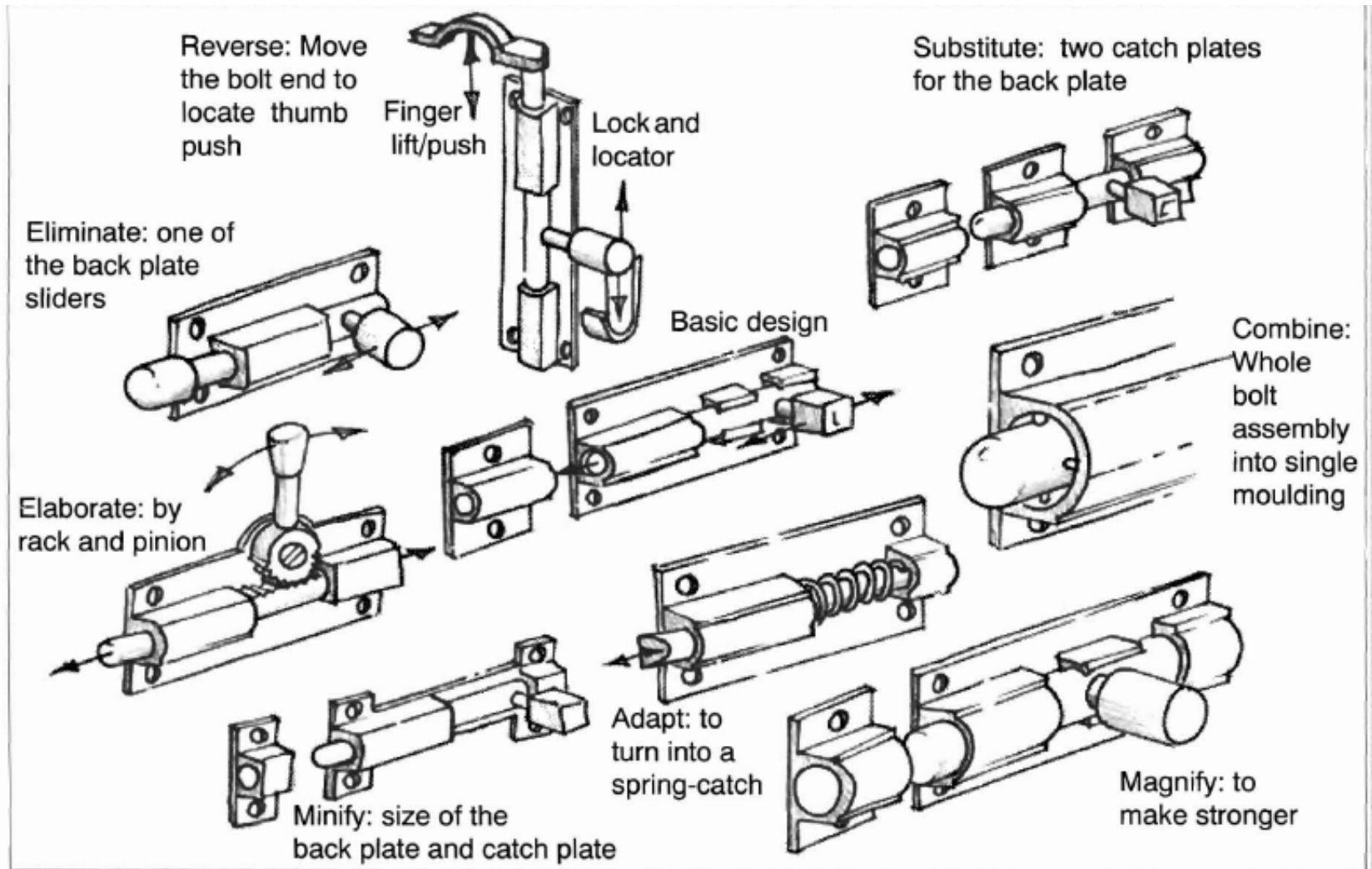

CREATIVITY

- Combine
- Reverse
- Enlarge
- Adapt
- Tinier
- Instead of
- Viewpoint change
- In other ways
- To other uses
- Yes!

Innovation through Design-by-Analogy

Analogy to Existing Products

Bioinspired Design

Dyson vacuum based on a saw mill dust collector



Dyson vacuum

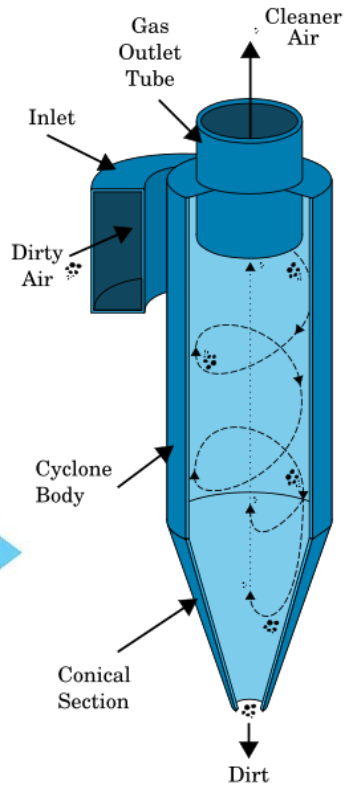

Dust Collector

Environmentally friendly, collapsible sail for cargo ships

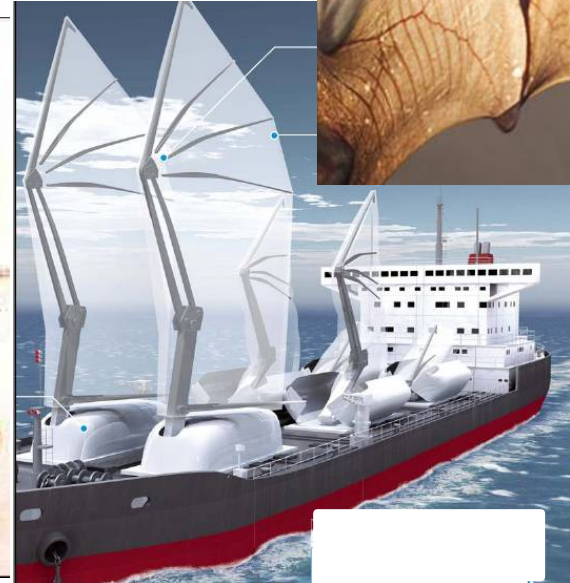

Opportunities for Participation in Research Studies

Makerspace Involvement and Design Self-Efficacy Survey

- Who can participate?
 - Any student enrolled in Capstone
- What is it?
 - Online survey about makerspace involvement, design self-efficacy, and demographic information
- Compensation: \$20
- Time required: 10-15 minutes

Idea Generation Activity

- Who can participate?
 - Capstone students who previously participated in this study
- Compensation: \$40
- Time required: 2 hours (max)

Questions? There are many more techniques and tools for idea generation

- Asknature.org
- WordTree Method for Analogy
- patents
- ideamache.ecologylab.net
- TRIZ/TIPS

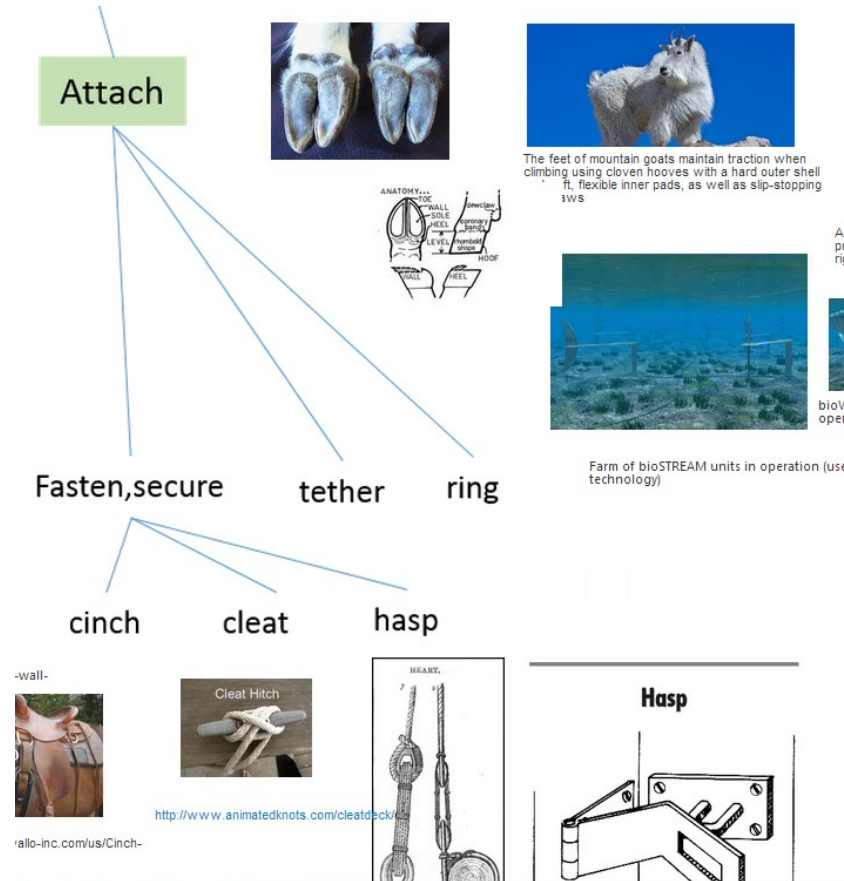

**Need Help? Appointments:
julie.linsey@me.gatech.edu**