

The protagonist is riding bicycle through the Crowded market  
the Screen reflects the movement of protagonist

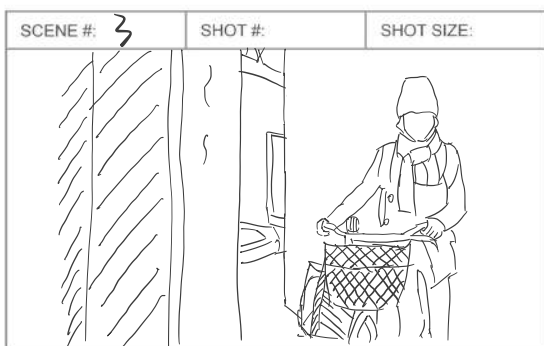

This Scene follows the Scene #1 the Camera changes the angle to focus the elder sits in the Store.



The protagonist pushes her bic

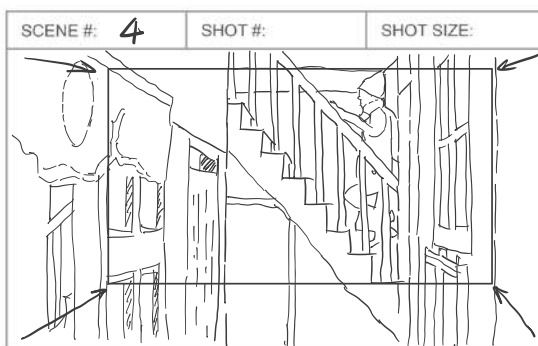

[Go upstairs] → the Camera follows the protagonist's movement.

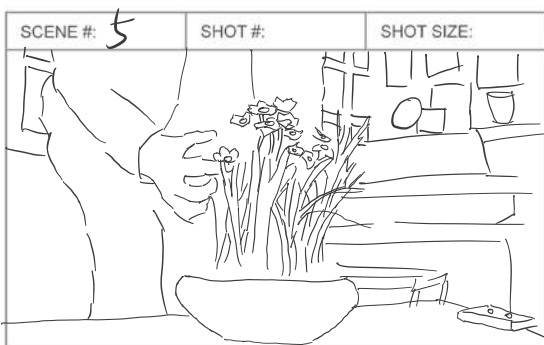

[This is a low angle scene]  
the protagonist puts down the plant

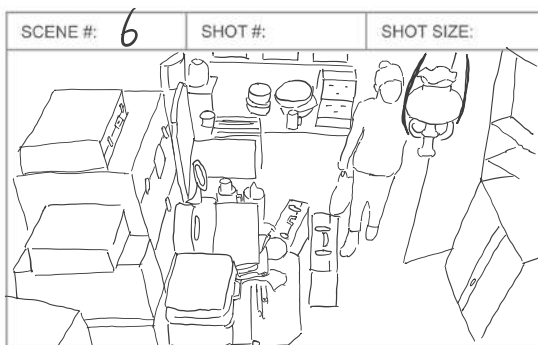

[high angle scene] give the comprehensive view of the room

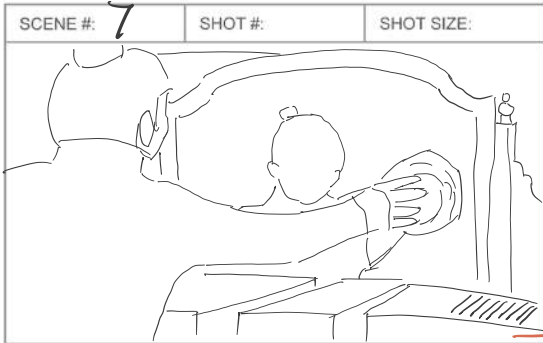

The protagonist is wiping the mirror.



the scene follows the scene #7. the protagonist find the old record in the box near to the mirror.

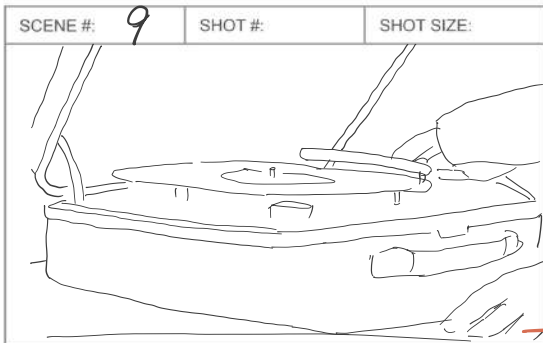

The protagonist puts the album to the recorder  
\*[ Background music begin.]



A wide view of her action to show the room.  
[ follows scene #9.]



\*[Another character: the grandma]  
to explain the relationship.

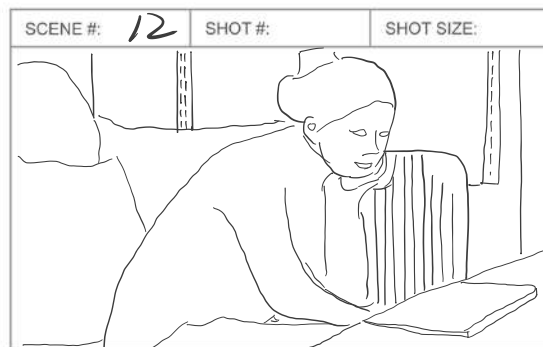

Emotion: thinking about something

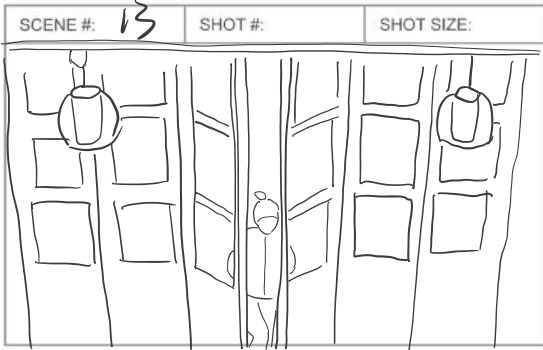

The girl is closing the door.

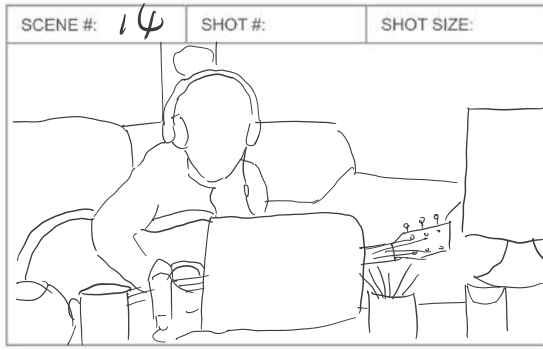

She is editing the music.

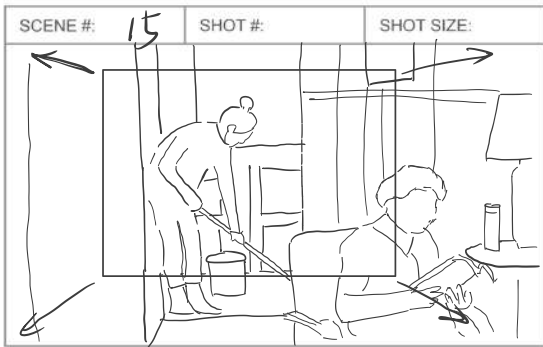

two characters show in the same scene.

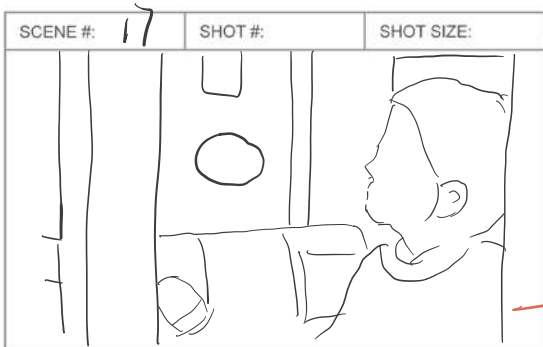
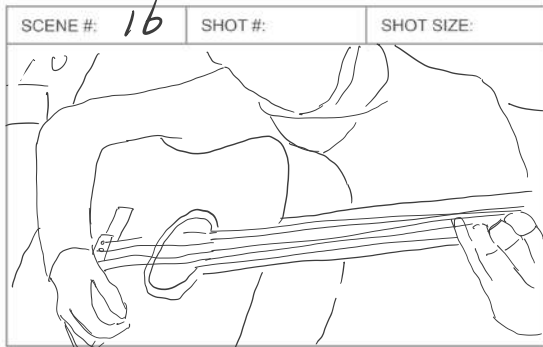

the grandma is amusing with pet bird.

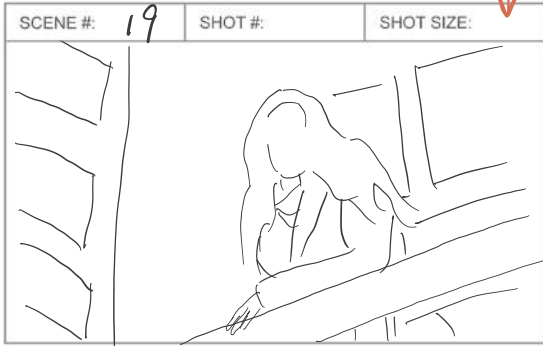

*the granddaughter is looking at her  
grandma in the Windowsill.*

